

1:1:2 Übertrager SM-T4

00 5532 58 Ind. 4

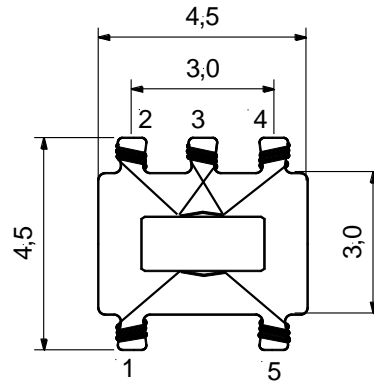
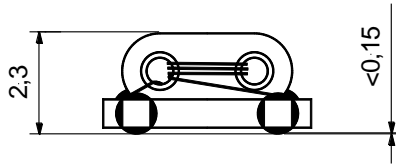

Einheit: mm

Schaltung

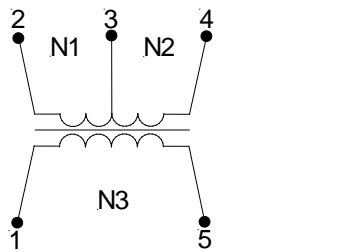

Lötflächen - Empfehlung

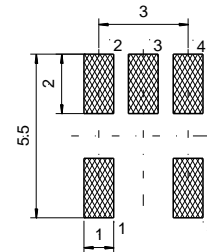

Elektrische Werte:

Wicklung Nr.:	L_{soll} [μH]	\pm %	f_{mess} [kHz]	Messgerät (oder äquivalent)	Bemerkung
1+2	10,3	20	100	HP4192A	
3	10,3	20	100		

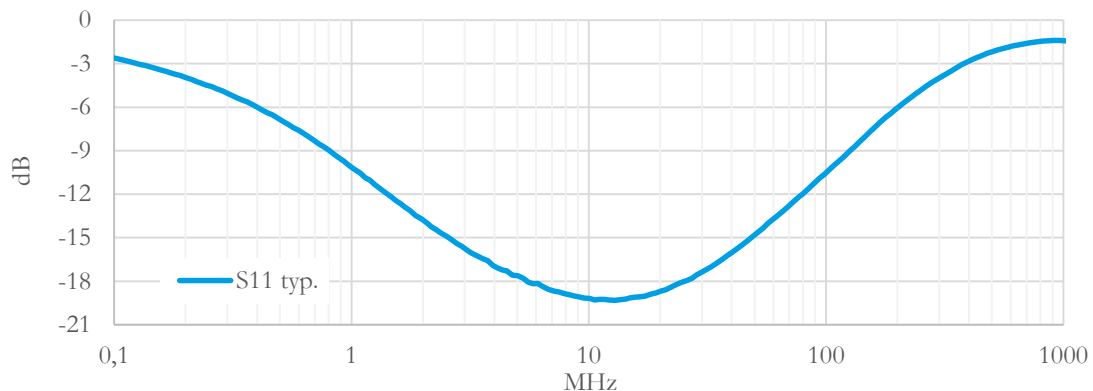
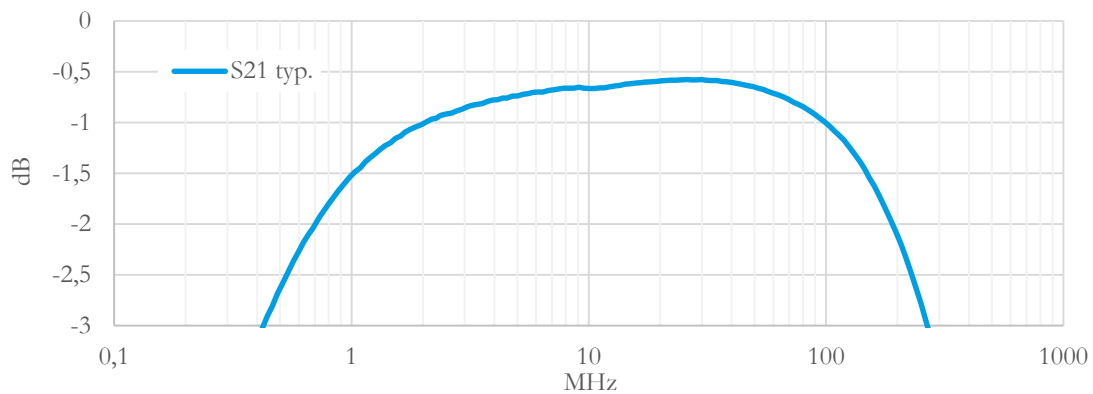

Alle Angaben ohne Gewähr. Irrtümer und Änderungen vorbehalten. No responsibility is taken for the correctness. Errors and changings reserved.

Verpackung:

Blisterverpackung: 79941535
 VPE: 500/2000 Stk./Rolle

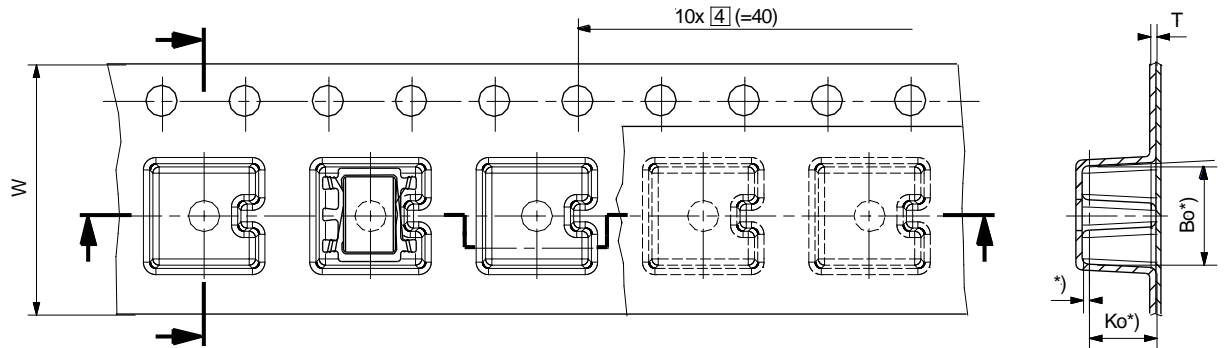

Ablaufrichtung (bestückt)
 aus der Haspel
 Direction of feed
 (equipped)

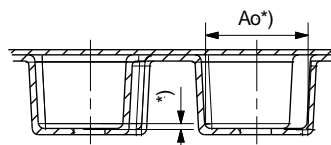
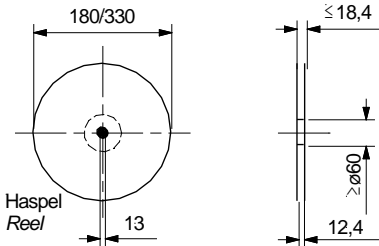

*) Gemessen im Abstand von 0,3 vom Boden.
 Measured at the end of radius (= 0.3 from bottom).

Ao	Bo	Ko	T	W
4.9	4.7	3.55	0.3	12

Blisterverpackung entsprechend DIN EN 60286/3: 2014 ausgelegt.
 Blisterpackaging acc. DIN EN 60286/3: 2014 designed.

Alle Angaben ohne Gewähr. Irrtümer und Änderungen vorbehalten. No responsibility is taken for the correctness. Errors and changings reserved.

1:1:2 Transformer SM-T4

00 5532 58 Rev. 4

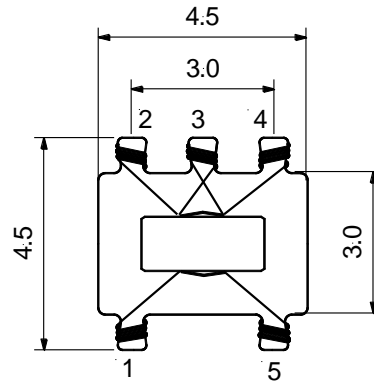
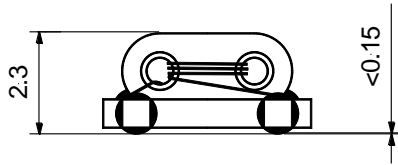

Einheit: mm

Schematic

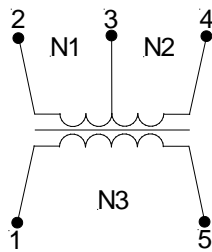

Solder Pad Recommendation

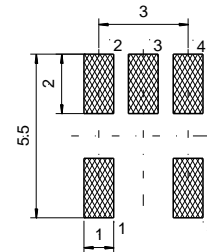

Electrical Data:

Winding No.:	$L_{nom.}$ [μH]	\pm %	$f_{meas.}$ [kHz]	Measurement instrument (or equivalent)	Remark
1+2	10.3	20	100	HP4192A	
3	10.3	20	100		

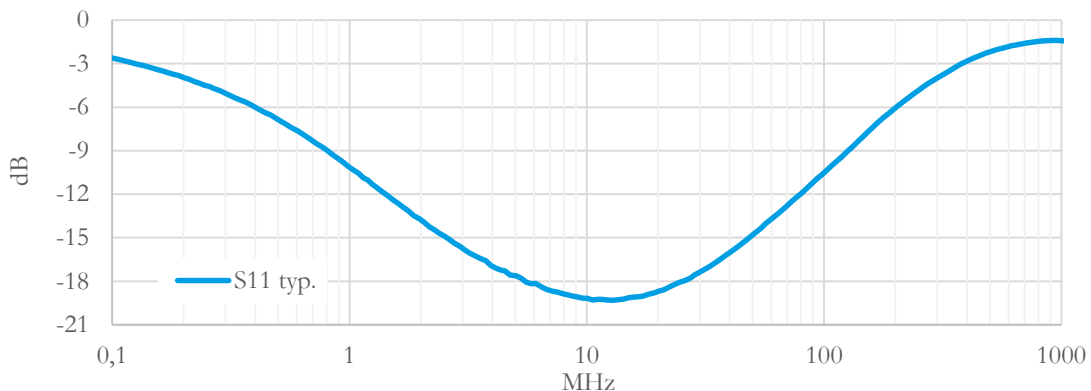
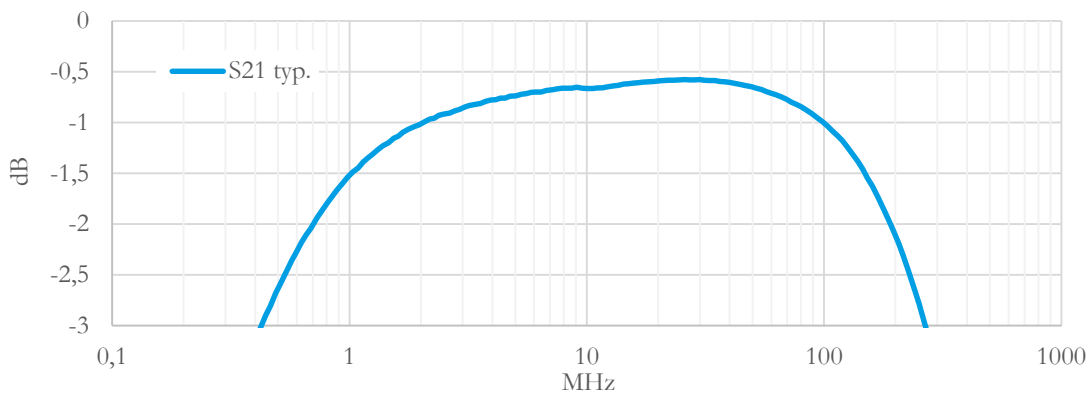

Alle Angaben ohne Gewähr. Irrtümer und Änderungen vorbehalten. No responsibility is taken for the correctness. Errors and changings reserved.

Packaging:

Blister tape: 79941535

VPE: 500/2000 pcs./reel

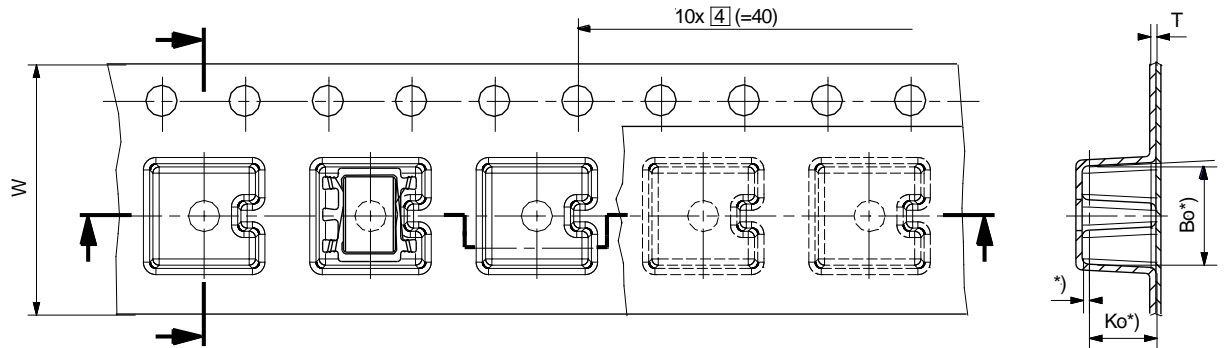

Ablaufrichtung (bestückt)
aus der Haspel
Direction of feed
(equipped)

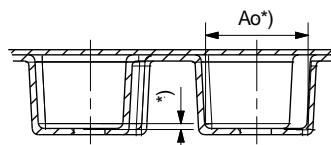
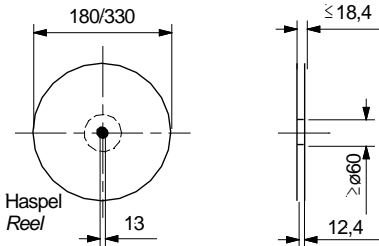

*) Gemessen im Abstand von 0,3 vom Boden.
Measured at the end of radius (= 0.3 from bottom).

Ao	Bo	Ko	T	W
4.9	4.7	3.55	0.3	12

Blisterverpackung entsprechend DIN EN 60286/3: 2014 ausgelegt.
Blisterpackaging acc. DIN EN 60286/3: 2014 designed.

Alle Angaben ohne Gewähr. Irrtümer und Änderungen vorbehalten. No responsibility is taken for the correctness. Errors and changings reserved.