

Zweifachverteiler

Two-way power combiner / divider

Kennzeichen

- Kompakte Bauform
- Automatisch bestückbar
- Für Reflow- und Dampfphasenlötung
- AEC-Q200 qualifiziert

Features

- Compact design
- Suitable for automatic insertion
- For reflow and vapor phase soldering
- Qualified to AEC-Q200

Anwendungen

Zellular/GSM, UHF / VHF, Receiver/Transmitter, PCN/PCS, GPS, VSAT

Applications

Cellular/GSM, UHF / VHF, receivers/transmitters, PCN/PCS, GPS, VSAT

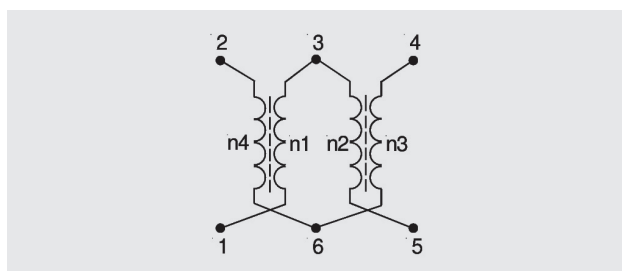
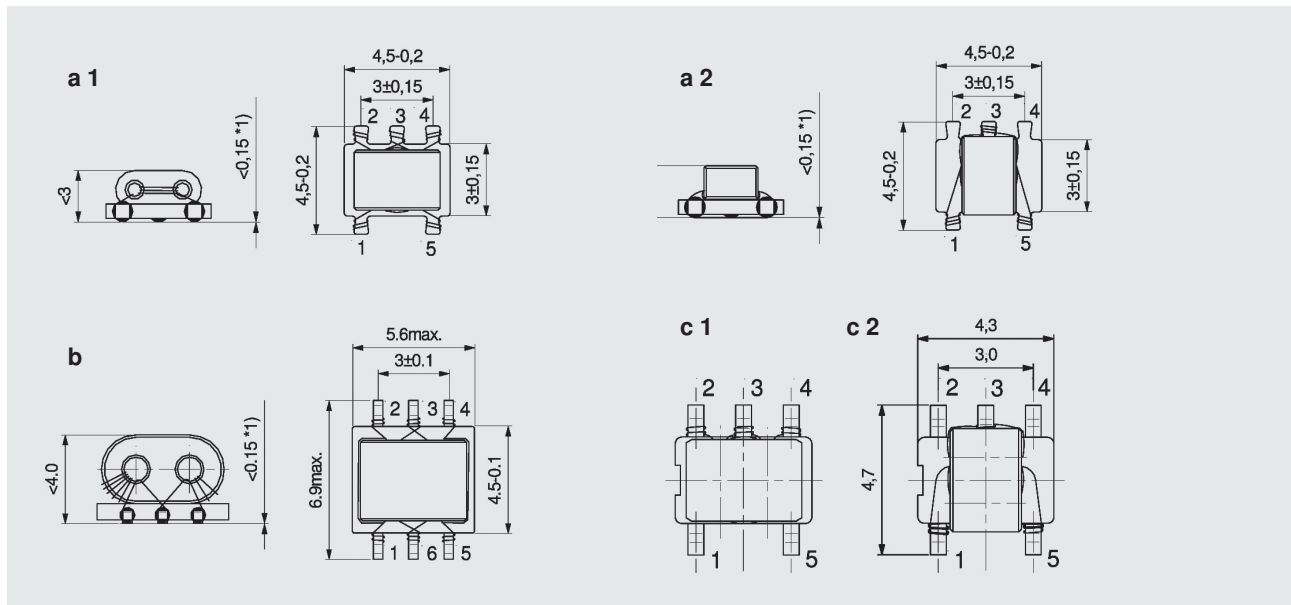

Betriebs-temperaturbereich:
-40°C bis +125°C
Max. Löttemperatur:
260°C, 10 Sek.

Operating temperature range:
-40°C bis +125°C
Max. soldering temperature
260°C, 10 sec.

Type	f	R	Form	Artikelnummer	Bemerkung
type	[MHz]	[Ω]	shape	Part number	notice
SM-T4	5-1000	75	a1 + a2	00 5532 60 + 00 5532 61	zweiteilig / two-part
SM-T53	5-1000	75	b	00 5531 32	einteilig / one-part
SM-T53	5-1000	75	b	00 5531 25	einteilig / one-part
SM-T4a	5-2500	75	c1 + c2	00 5539 03 + 00 5539 05	zweiteilig / two-part

Weitere Typen auf Anfrage
Other types on request

Typische Werte | Typical values

00 5532 60 + 00 5532 61

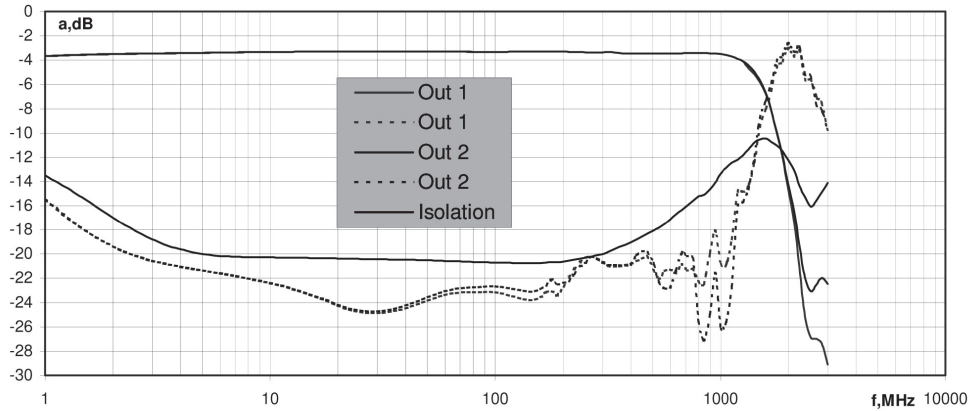

00 5531 32

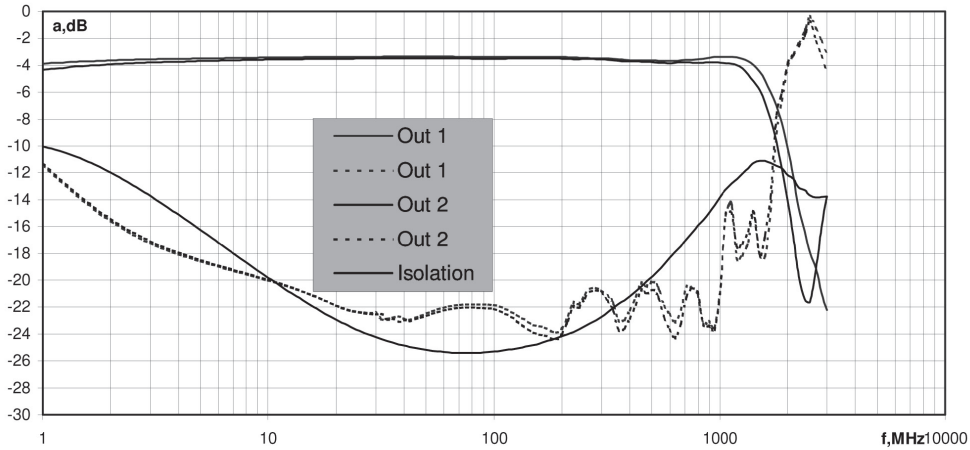

00 5531 25

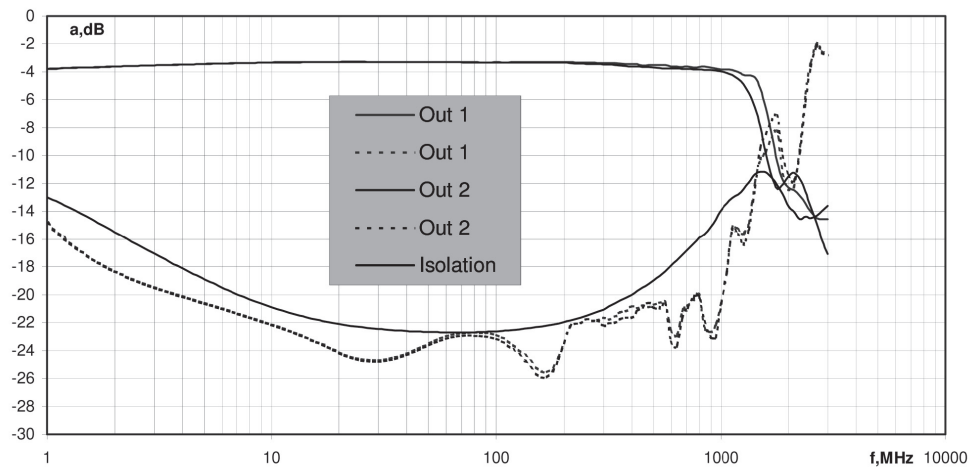

Zweifachverteiler

Two-way power combiner / divider

Typische Werte | Typical values

00 5539 03 + 00 5539 05

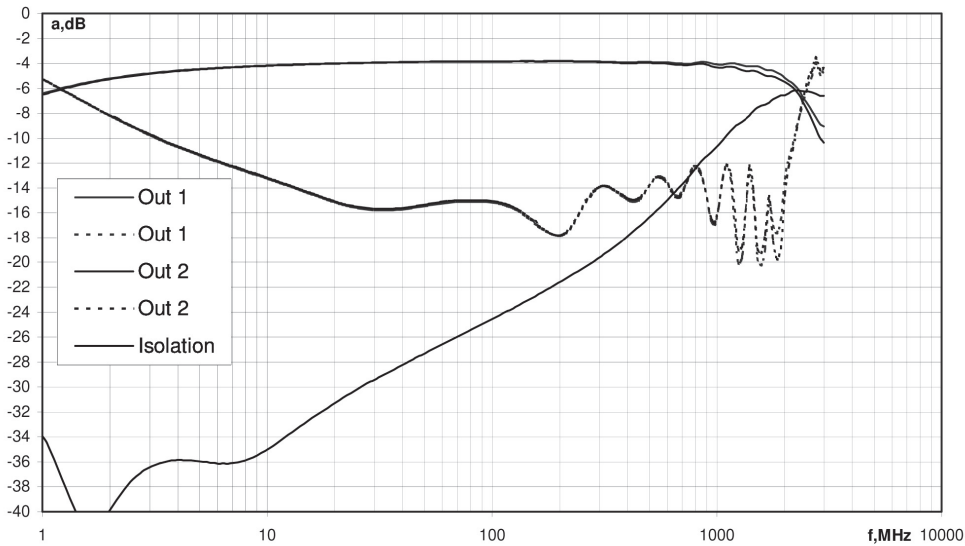

Messaufbau und Empfehlung für Lötflächenmaße (mm) für SM-T 53
 Measuring assembly and recommended pad pattern (mm) for SM-T 53

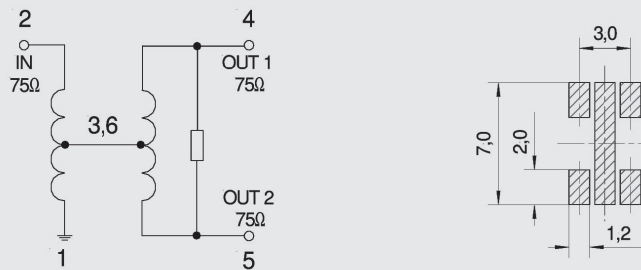

Messaufbau und Empfehlung für Lötflächenmaße (mm) für SM-T4 / SM-T4 a
 Measuring assembly and recommended pad pattern (mm) for SM-T4 / SM-T4 a

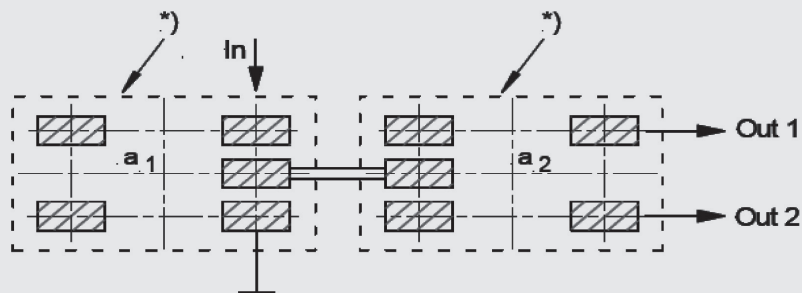

*) Pad pattern for SM-T4